

Sink Milanello Gold Workstation

Kitchen Sinks

Code: 1034 859

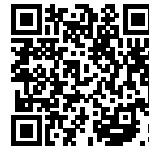

DETAILS

Coloring Gold

Edge/Installation Type Undermount

Finish PVD

Material AISI 304 stainless steel

Texture Brushed in line

Base 90 cm

Dimensions 790x466 mm

Standard fittings Fixing hooks, gasket, drain, overflow and siphon, boxed packing

Mixer holes No standard holes

Built-in hole [View technical data sheet](#)

Drainer No

Width 79 cm

Bowl dimension 750 x 374 mm

Number of bowls 1 bowl

Waste fitting 3,5" Gold drain

EQUIPMENT

2 x Black grid Milanello 8100
602

FEATURES

Gold The Gold finish is obtained by treating the steel with a physical process called PVD (Physical Vacuum Deposition) which deposits particles of noble metals on the surface. The result is a unique and refined aesthetic effect, and an improvement in the mechanical properties of the steel that is more resistant to shocks and scratches.

Basket 3,5" waste fitting The drain is equipped with a large 3.5" drain, with the practical basket cap that prevents the discharge of solid parts.

Diamond-shape bottom The draining of water is an important feature in a sink, and it's always taken good care of in Foster products. In the bent-welded sinks, which would have a flat bottom, the proper draining is guaranteed by the elegant beveling, which helps the water flow.

High thickness 1mm thick steel. A significant thickness, which guarantees the maximum sturdiness and durability.

Perimetral overflow

The overflow is always a security on the Foster sinks that prevents the overflow of water in case of oversights. The perimeter drain solution improves aesthetics thanks to its square and essential shape.

Save space system

Drain and siphon are designed to leave as much space as possible in the under-sink area, more and more useful today for theseparate waste collection systems.

Triple recess - sliding accessories

The Foster Milano sink has an ingenious design that makes it simple to use a large set of optional accessories. On the topmost supporting step, the innovative Black grids slide, creating a large and practical surface to rinse food and crockery. The second step is meant to support and allow the sliding of a complete combination of accessories, which make some operations practical and safe: rinse, drain, slice, grate... everything can be done inside the sink. The third supporting step is on the bottom of the bowl. On this step one can rest the Black grids, making it possible to rinse foodstuffs without their coming in contact with the bottom of the sink, which may be dirty.

TECHNICAL DATA

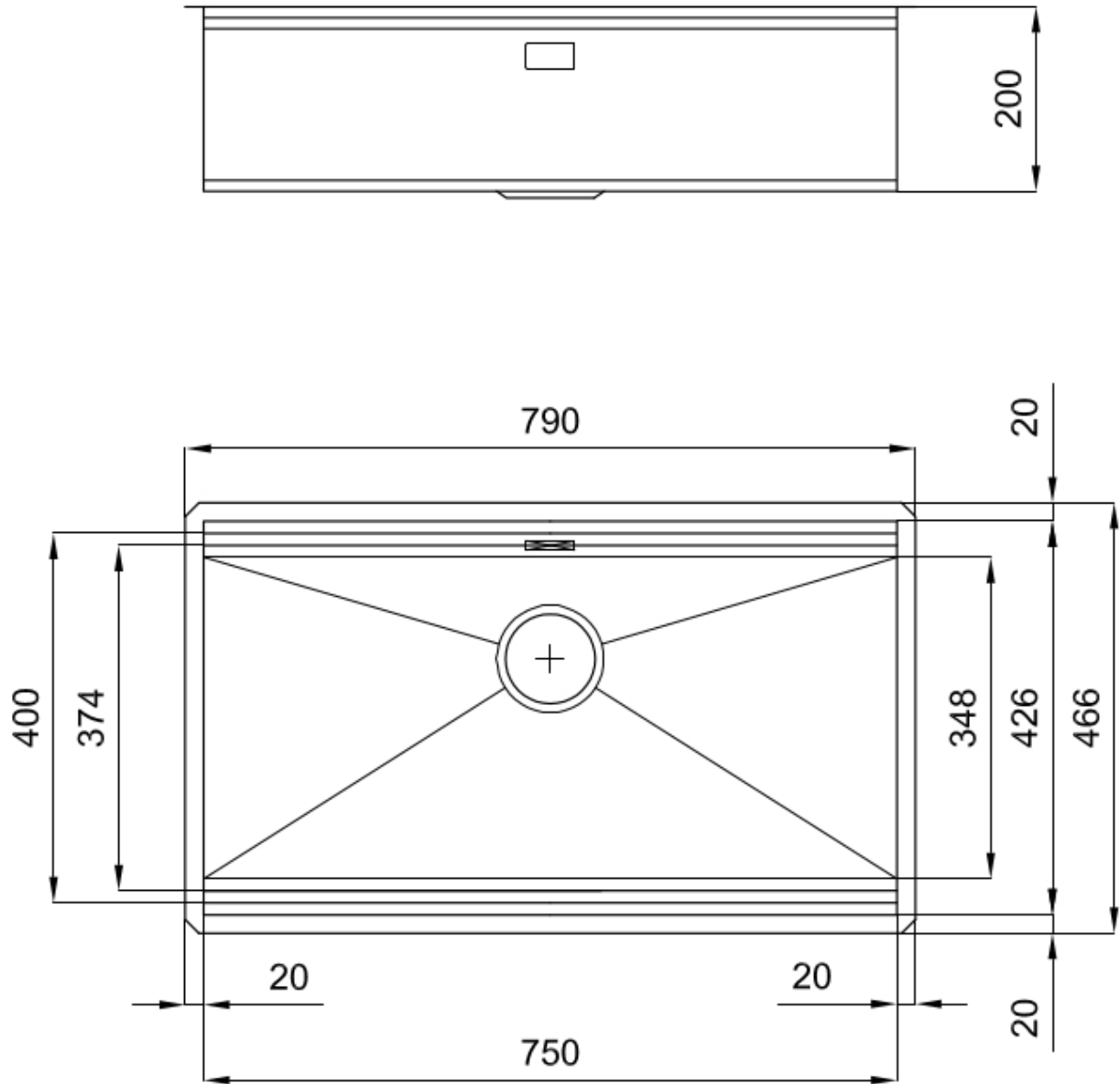

Milanello Optional accessories / Accessori opzionali

The "rails" system makes it possible to use a combination of numerous accessories. Grids, chopping boards, utensils' ranging system, bowls and containers of different dimensions can be alternated in the workspace with a simple gesture, and can easily be stacked, in order to be on hand at all times.

Il sistema di "corsie" rende possibile l'utilizzo combinato di innumerevoli accessori. Griglie, taglieri, portautensili, vaschette e contenitori di varie dimensioni si alternano nella zona di lavoro con un semplice gesto e possono essere impilati, sempre a portata di mano.



Milanello Level 1

Compatible accessories/Accessori compatibili:

8100 602
8631 300
8642 003
8644 004
8644 101
8657 001



Milanello Level 2

Compatible accessories/Accessori compatibili:

8100 306

8156 000

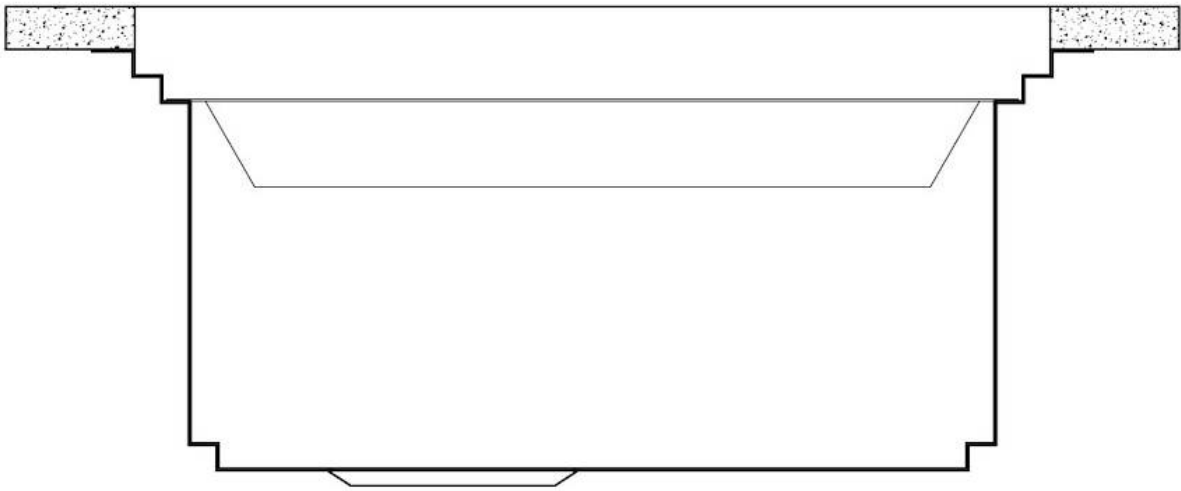

Milanello Level 3

Compatible accessories/Accessori compatibili:

8100 602

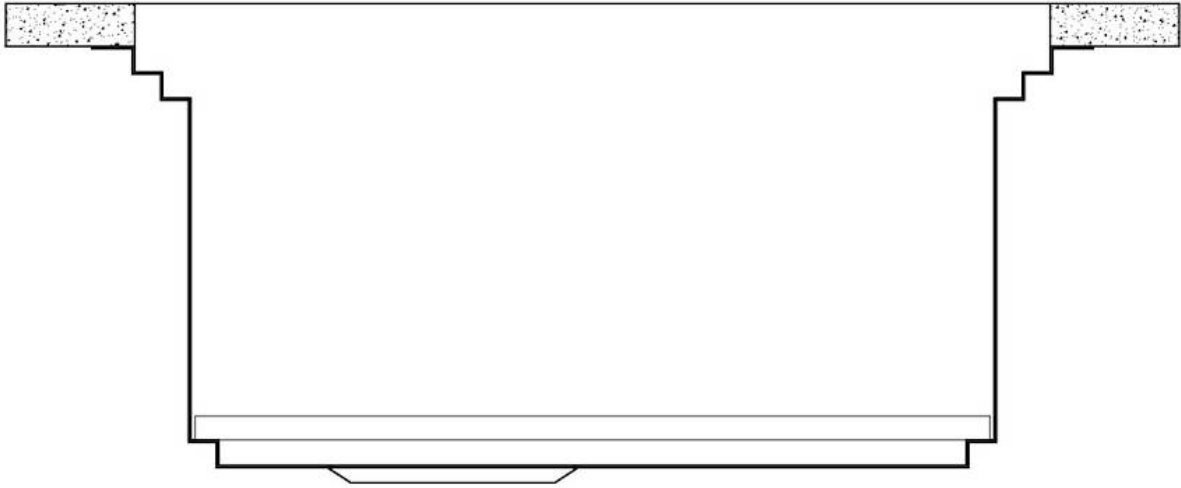

750

426

Cut out size - Dimensioni per foratura top

GALLERY

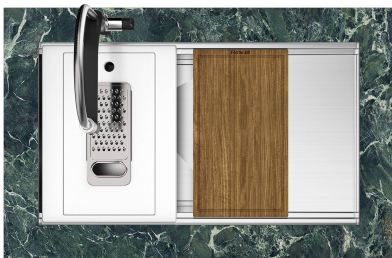
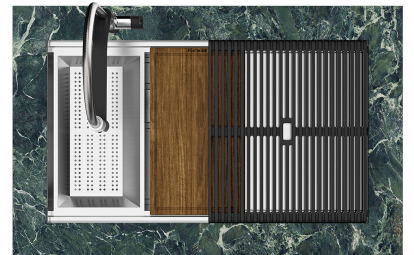
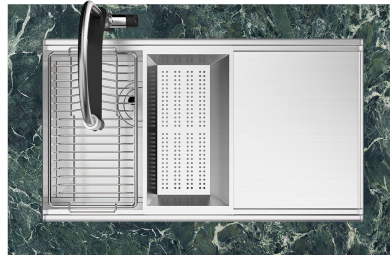
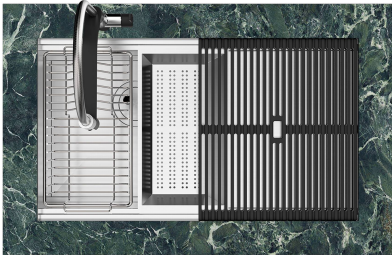
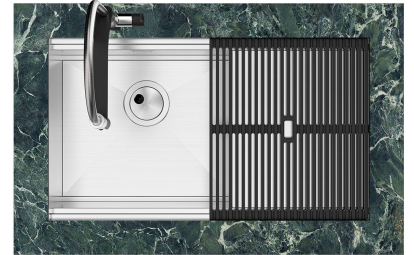

EQUIPMENT



Black grid Milanello
8100 602

OPTIONAL ACCESSORIES



HPDE Chopping board
8657 001



HPDE Twin chopping board
8644 101



Stainless steel perforated tray
8156 000

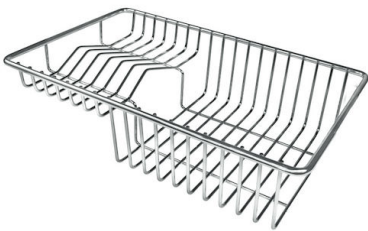

Stainless steel plate rack
8100 303

* only in combination with the accessory
8644 101

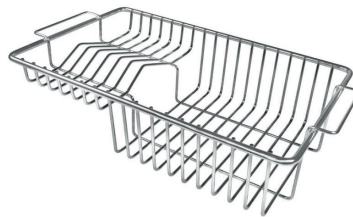

Stainless steel Plate rack
8100 306



**Stainless steel plate rack only
usable in combination with the
accessories 8644 003**

8100 154



Glass chopping board
8631 300



Graters kit with ring-holder and food collection tray
8159 101
* only in combination with the accessory
8644 101



Stainless steel perforated tray
8151 000
* only in combination with the accessory
8644 101



Walnut-wood chopping board
8642 004

RECOMMENDED PAIRINGS

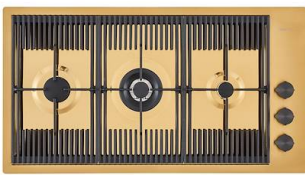

Cooker hob Milanello Gold
7680 009

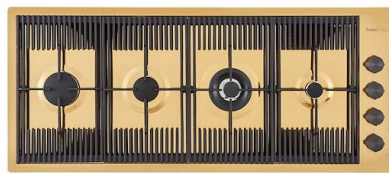

Cooker hob Milanello Gold
7681 009



Mixer Tap Omega Gold
8497 700